

Silexa Draft Beer Counter X3M LZ



1 Index

| | | |
|------|-------------------------------|----|
| 1 | Index | 2 |
| 2 | General introduction | 4 |
| 3 | Functions | 4 |
| 3.1 | General | 4 |
| 3.2 | Memory | 4 |
| 3.3 | Connections | 4 |
| 3.4 | Backup battery | 4 |
| 3.5 | Housing | 4 |
| 4 | Installation | 5 |
| 4.1 | General | 5 |
| 4.2 | How to open the device | 5 |
| 4.3 | Connections of the board | 6 |
| 4.4 | Connecting the flow meter | 6 |
| 4.5 | Connecting the backup battery | 6 |
| 4.6 | Wall mounting | 7 |
| 4.7 | Sealing the housing | 7 |
| 5 | Operation | 8 |
| 5.1 | General operation | 8 |
| 5.2 | Switch on | 8 |
| 5.3 | Standby | 8 |
| 5.4 | Restricted menu | 9 |
| 5.5 | Code registration | 9 |
| 5.6 | Full menu | 9 |
| 6 | Configuration | 10 |
| 6.1 | General | 10 |
| 6.2 | Configuring pipelines | 10 |
| 6.3 | Unit | 12 |
| 6.4 | Unit (short) | 12 |
| 6.5 | Decimal places (Display) | 12 |
| 6.6 | Decimal places (reporting) | 13 |
| 6.7 | Decimal separator | 13 |
| 6.8 | Date notation | 13 |
| 6.9 | Time/Date | 14 |
| 6.10 | Day changeover | 14 |
| 6.11 | Manager key | 15 |
| 6.12 | Reset lines with manager key | 15 |
| 6.13 | Code login | 15 |
| 6.14 | COM1 | 16 |
| 6.15 | Language | 16 |
| 6.16 | Factory defaults | 17 |
| 7 | Reporting | 18 |
| 7.1 | General | 18 |
| 7.2 | Select lines | 18 |
| 7.3 | Reporting Day | 19 |
| 7.4 | Reporting Month | 19 |
| 7.5 | Reporting All | 19 |
| 7.6 | Reporting Timespan | 19 |
| 7.7 | Clear all data | 19 |
| 7.8 | Reset line(s) | 20 |
| 8 | Printer | 20 |
| 8.1 | General | 20 |
| 8.2 | Connecting a printer | 20 |
| 8.3 | Printing reportings | 21 |
| 9 | Cleaning | 21 |
| 10 | Events | 22 |
| 10.1 | General | 22 |

| | | |
|------|-------------------------|----|
| 10.2 | New events _____ | 22 |
| 10.3 | All events _____ | 23 |
| 10.4 | Power supply _____ | 23 |
| 10.5 | Flow meter _____ | 23 |
| 10.6 | Cleaning _____ | 23 |
| 10.7 | Other _____ | 23 |
| 10.8 | Mark all as read _____ | 23 |
| 10.9 | Clear all data _____ | 24 |
| 11 | Battery operation _____ | 25 |

2 General introduction

The Silexa Draft Beer Counter X3M LZ allows seamless control of up to 8 beverage pipelines. Regardless of whether beer, wine or soda - it can record all data of the pipelines and provide them as incident reports and evaluations.

The simple and intuitive operation does not require extensive training. The configuration and calibration can be executed directly on the device. In addition, the PC software "Silexa X3M LZ configuration" is available to make considerably and more detailed evaluations.

The Silexa Draft Beer Counter X3M LC is available in two versions. With the Silexa Draft Beer Counter X3M LZ-4 enable the control of up to 4 beverage pipelines, while the variant X3M LZ-8 supports up to 8 pipelines. Subsequently, in this instruction manual the variant for 8 pipelines, the Silexa Draft Beer Counter X3M LZ-8 is described.

3 Functions

3.1 General

The Silexa Draft Beer Counter X3M LZ provides control of up to 8 beverage pipelines.

The configuration of the Draft Beer Counter is locked for waiters. Only authorized persons can change settings on the device. For authentication you can use an iButton socket wrench or a pre-defined code.

3.2 Memory

The device is able to save and provide data for evaluation, up to 4 years, based on the number of used pipelines. In the background, the events of the flow meter, power and memory be logged. All data are stored in a special memory device and are stored even after a total power failure.

The battery-backed real time clock is ensured with a button cell, so this is secured too.

3.3 Connections

Besides the 8 flow meters the Draft Beet Counter can be connected with a printer via the serial port. With this connection all reports can be printed.

3.4 Backup battery

An additional backup battery allows the normal operation even in case of power failure. A standard 9V battery can operate the Silexa Draft Beer Counter X3M LZ approximately 2 to 3 hours ahead.

3.5 Housing

The housing of the Silexa Draft Beer Counter X3M LZ can be used as a stand- and tabletop device. It is also possible to mount the device on a wall (there are prepared bores).

The device provides protection against manipulation because it can be sealed.

4 Installation

4.1 General

Before the device can be put into operation, all lines must be connected first. Thereafter, the configuration and calibration of the pipelines can be implemented.

4.2 How to open the device

To open the device, fold the two flaps on the right and left side of the housing away.

There are 4 screws with which you can open the housing.



After this you can lift the top part and open the housing.

The top part is connected to the housing base with two plastic pins, so it can not fall down. The top part is also connected through two flat cables with the board.

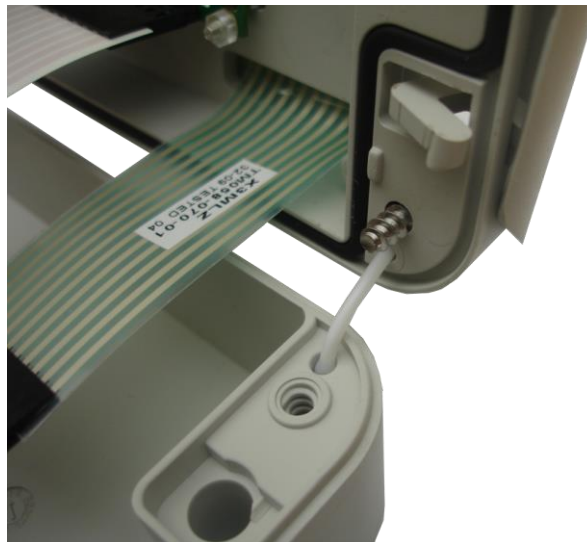

4.3 Connections of the board

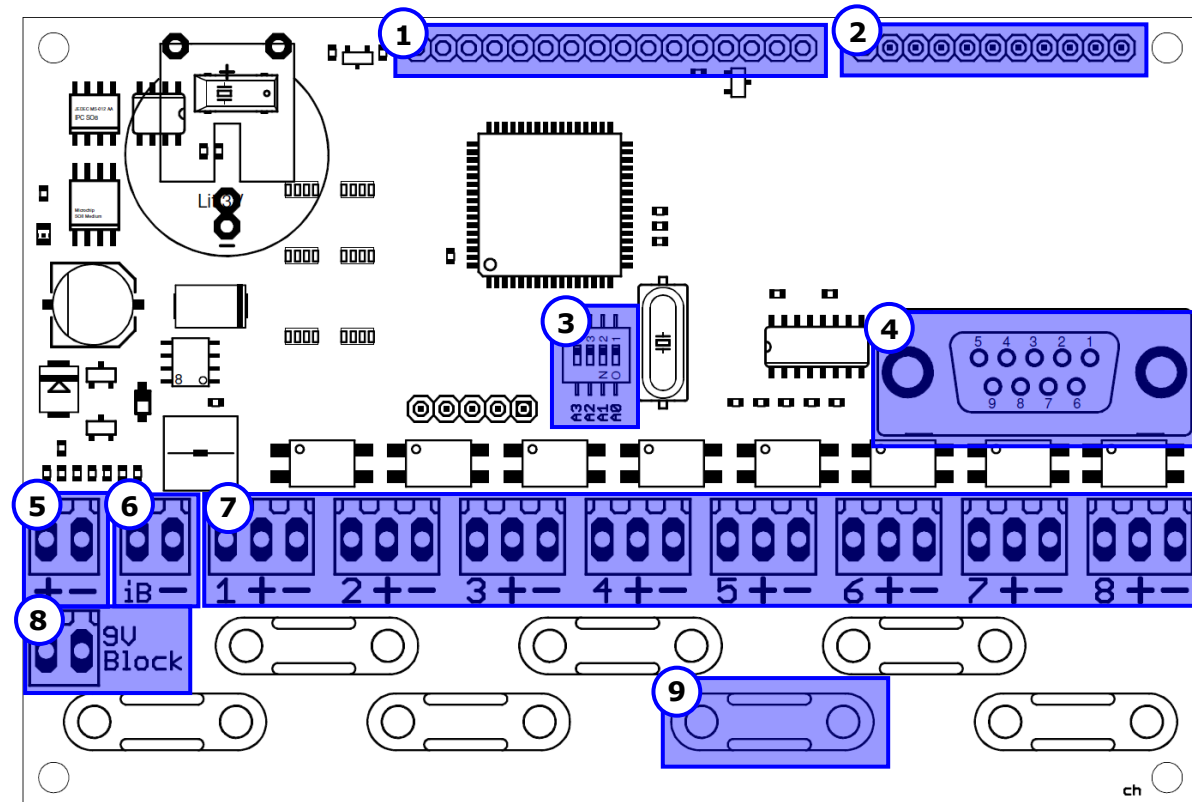

| No. | Description |
|-----|---|
| 1 | Connection for Display |
| 2 | Connection for membrane keypad |
| 3 | Address switch |
| 4 | Serial interface for connection to the PC |
| 5 | Power supply (9V= 500mA) |
| 6 | iButton-lock |
| 7 | Connections for flow meters |
| 8 | Connection for 9V battery as a backup battery |
| 9 | Clamps for strain relief |

4.4 Connecting the flow meter

On the Silixa Draft Beer Counter X3M LZ all commercially available flow meter can be connected. These are connected with the device by a 3-wire cable.

| Connection | Description |
|------------|--|
| 1 ... 8 | Conjunction of the flow meter |
| + | Supply voltage of the flow meter On this line gives the Draft Beet Counter = 9V |
| - | Mass of the flow meter, often GND |

Then the cable can be fixed via one of the 7 clamps for strain relief on the board.

4.5 Connecting the backup battery

The backup battery is a commercially available 9V battery. This is connected to the battery clip and fixed in the top part. If the battery is properly connected, a battery symbol appears on the standby screen display.

4.6 Wall mounting

The housing has 4 holes for mounting on a wall. The hole pattern is located on the back of the device.

The horizontal spacing of the holes is 139mm, the vertical is 34 mm.



4.7 Sealing the housing

On the back of the housing, next to the holes for wall mounting there is another hole.

Into this hole, a special sealing pin can be placed, which then stand proud to the top of the housing.



The sealing pin can then be fixed with a special cable tie or a lead seal, so the housing can not be opened undetected. A second sealing pin can be used on the opposite side.

In this way, manipulation can be excluded.



5 Operation

5.1 General operation

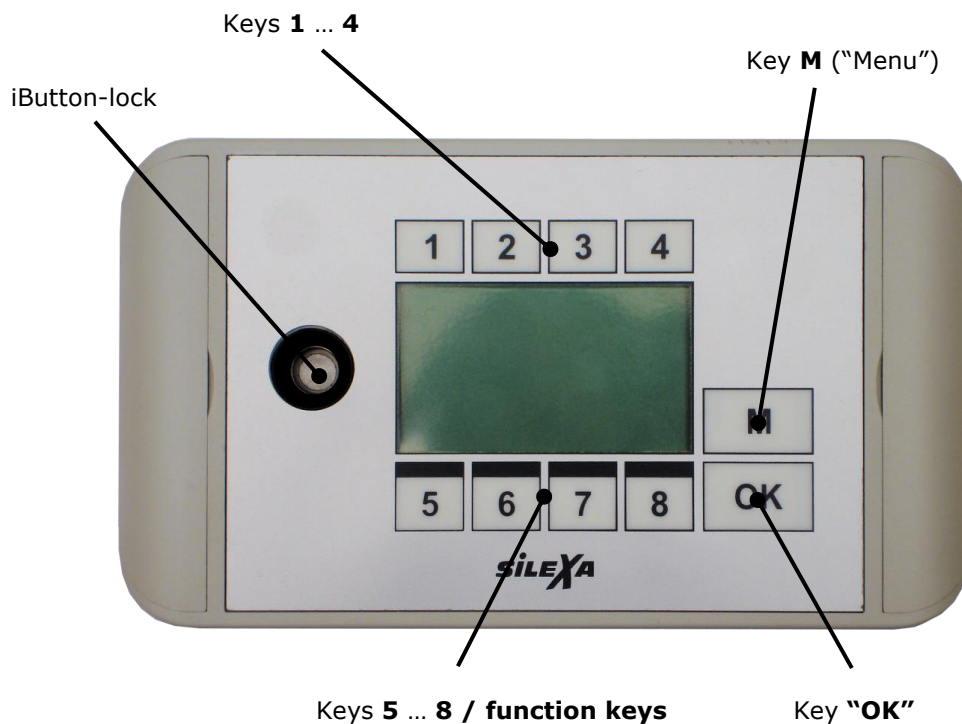

With the keys **1** to **8** you can choose the pipeline which should be displayed on the standby display. The key **M** opens the main menu. Within the menu the "M" menu button is used to return to the parent menu, or leave it. With **OK** confirm or implemented a selection.

While navigating through the menus, the function keys **5** to **8** will receive a special function, which appears at the bottom of the display in a black border as a symbol or text.

5.2 Switch on

The Silexa Draft Beer Counter X3M LZ gets switched on by plugging in the AC adapter plug. The device is not equipped with a main switch, because it is designed for continuous operation.

5.3 Standby

The standby screen shows a summary of all configured lines with the current volume. Furthermore, in the title bar displays the current time and status symbols.

| 11.10.09 09:22:14 | | | |
|-------------------|-------|---|--------|
| 1 | 2,65l | 5 | 5,28l |
| 2 | 2,06l | 6 | 21,22l |
| 3 | 0,72l | 7 | 4,48l |
| 4 | 3,81l | 8 | 2,68l |

With the keys **1** to **8** a line can be selected which will be shown in detail.

The detail view now displays the names of the elected pipeline and the current volume. In addition, the line number and the adjusted commodity codes will be displayed.

At the bottom of the display are 8 flow meter icons. These indicate the activity on the respective sensor by

| 11.10.09 10:35:23 | |
|-------------------|--|
| Line 1 - PLU 1 | |
| Leitung 1 | |
| 2,66 Liter | |
| | |

turning the symbolic paddle wheel. Non-member flow meters are displayed as dotted symbols. From this screen a different pipeline can be directly chosen for detailed view.

With the keys **OK** and **M** you can go back to the Standby display.

5.4 Restricted menu

With the key **M** the main menu can be accessed from the standby screen. The function keys **↑** and **↓** the menu item can be selected and confirmed with **OK**.

First only the minimal menu is shown, because without authentication no configuration or analysis is possible.

For authentication there can be an iButton socket wrench or a code application. Both can be configured and be explained under "Configuration".



Behind the menu option "Information" you can find a short list of important device information. It displays the software version and the software date. In addition, this screen shows the measured voltages of the supply and the battery.

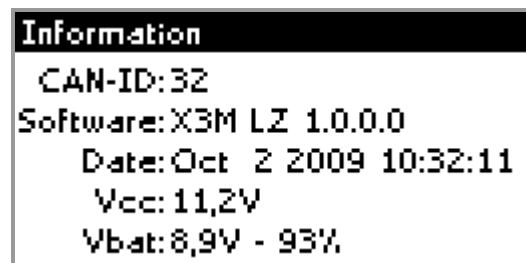

5.5 Code registration

The menu item "Code login" allows you to sign in by entering a code.

In the work state the code is set with "1234", but can be changed in the configuration. The code can be entered via the keys **1** to **8** and gets confirmed with **OK**.



If you enter an incorrect code, it is reported and the command can be carried out again. With **M** the Code Registration can be exited.

When you have entered the code successful, the full menu appears.

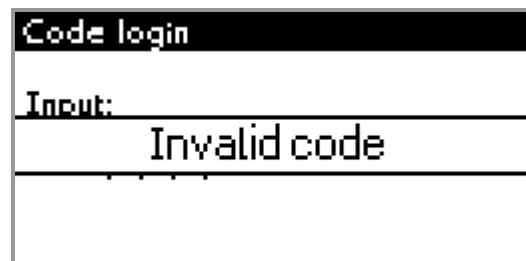

5.6 Full menu

Following the successful application of a code or a valid iButton socket wrench, the full menu is displayed.

In this menu, the entire device can be configured and evaluated. Here the cleaning function can be started and the latest events can be viewed.

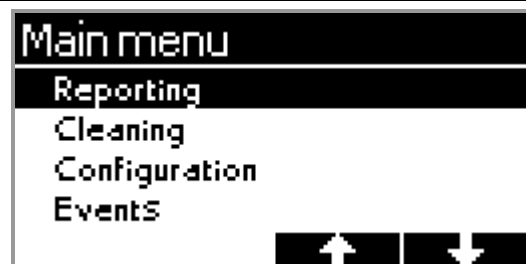

6 Configuration

6.1 General

The entire configuration of the device can be changed with the menu item "Configuration" in the "Main menu".



6.2 Configuring pipelines

6.2.1 General

All settings of the pipelines can be changed with the menu item "Configure lines".

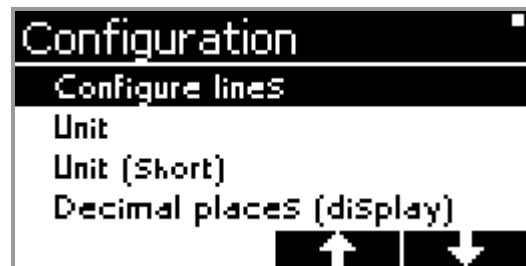

In the next menu the pipeline which should be configured has to be selected. In the list, both the pipeline number and the pipeline name is displayed.

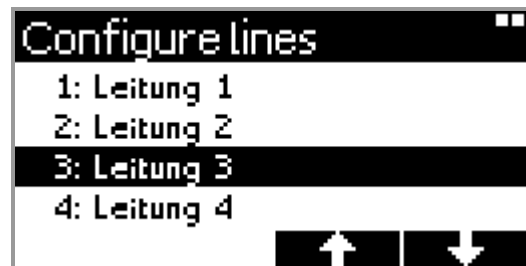

Now all options are displayed for that pipeline. In the title bar, the number and the name of the selected pipeline is displayed.

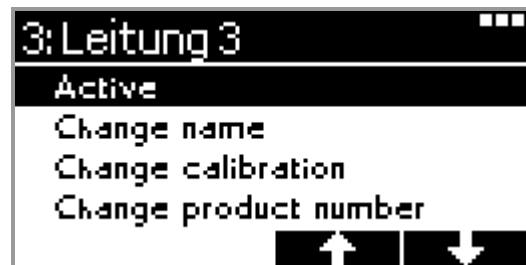





6.2.2 Actual



The "Actual" option allows you to turn off individual pipelines. Thus the pipeline can be taken from the monitoring and control. Is "Active" set to "No" the pipeline appears not longer on the standby screen.





6.2.3 Change name

The menu item "Change name" allows the use of a freely-definable name for the pipeline.

With the function keys  and  the characters get elected, which gets added with  to the name. The function button  allows you to choose between different character sets (uppercase, lowercase and special characters).

To delete a character, the character must be chosen with  and confirmed with .

The input can be confirmed and saved with  or by pressing  aborted and discarded.

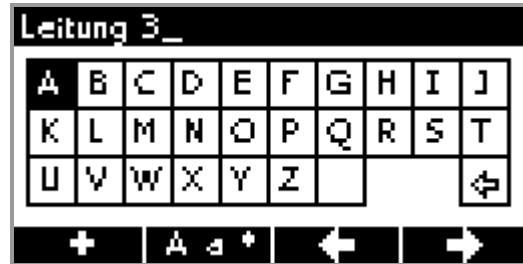



6.2.4 Change calibration

Before a pipeline can be put into operation it must be calibrated first to the medium used.

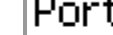
During the calibration there must be tapped 1.0 Units (liters) on the selected pipeline. The Draft Beer Counter counts the pulses. The tapping is symbolically shown by the flow meter icon in the lower left corner. Ideally, the tapping is carried out without interruption.

After the calibration of the measurement can be readjusted with the function keys  and .





With the key  the measured value can be set to zero and the calibration process is starts new.

The measurement can now be confirmed and stored with  or cancelled and discarded by pressing .



6.2.5 Change commodity code

For each line can product number (also called "PLU") can be established. Pipelines with the same commodity number are summarized in the evaluation. Thus several lines with the same product can even be aggregated in the evaluation.



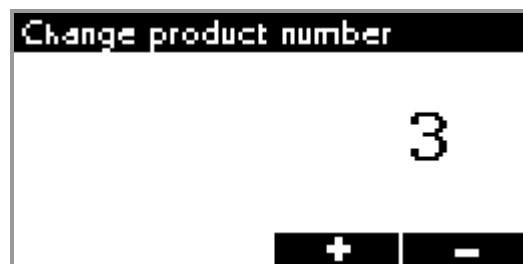

With the function keys  and  the commodity number get increased or decreased. The new value is now confirmed and stored with  or discarded with the key .







6.3 Unit

In the menu "Configuration", the unit can be set. The unit is a user-defined character string that is used only for display.

Default "Liter" is entered. If, however, for other applications or countries it can be changed to "pint" or "ounce".

To change this designation selected with the function keys  and  the next character, which is added with . The function button  allows you to choose between different character sets (uppercase, lowercase and special characters).

To delete a character, the character must be chosen with  and confirmed with .

The input can be confirmed and stored with , or by pressing  be aborted and discarded.

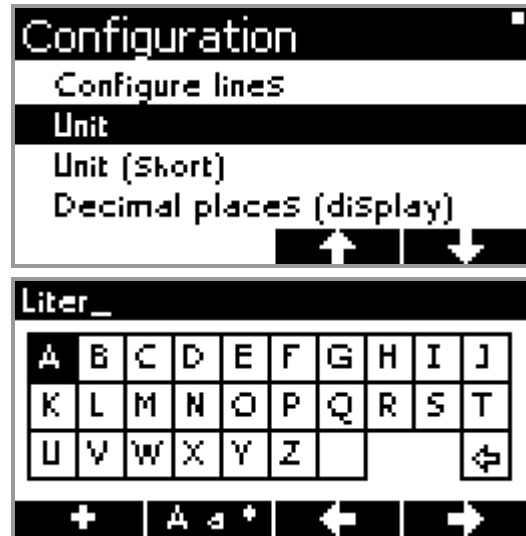

6.4 Unit (short)

"Unit (short)" is the abbreviation for the above-defined unit. For "Liter" the default value is "l" and can be changed in the same manner as the unit.

This term is also used for the display.

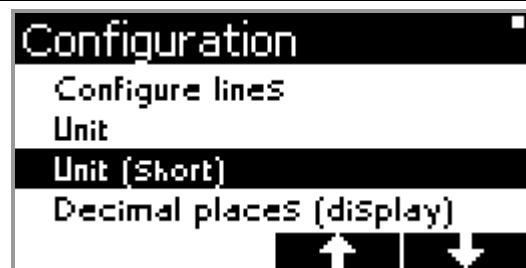

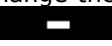

6.5 Decimal places (Display)

Furthermore responsible for the display is the setting of the Decimal places (Display). Here the number of decimal places is configured, which will appear in representation of a volume number.

To change the value press the function keys  and  to increase or decrease the number of decimal places

The value can be set from 0 to 2.

The new value is now confirmed and stored with  or discarded with the key .

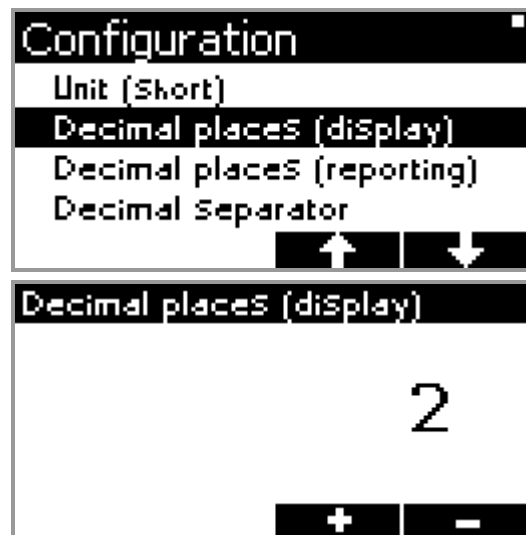

6.6 Decimal places (reporting)



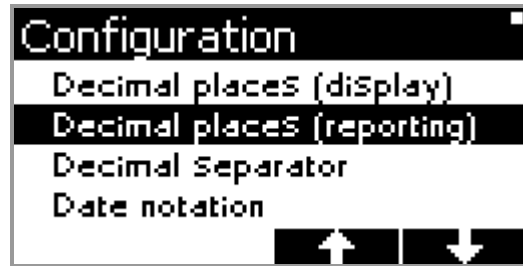

The number of decimal places for the reporting can be specified separately. This setting affects all volumes in the evaluation and on printed evaluations.

As described above here the value can also be changed to a value from 0 to 2.



6.7 Decimal separator

To adjust the settings for other countries, the decimal separator can also be changed.



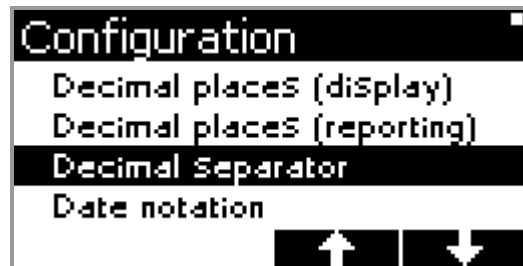

There can be chosen between the comma (,) and point (.) with  and . The new setting is saved and confirmed with the key  or discarded with the key .



6.8 Date notation

The date notation determines the order of day, month and year as well as the separator between these elements of the date display.

To meet international standards the date display can be changed between the notations (day.month.year) and (month/day/year).

With the keys  and  there can be chosen between the two shown notations. The actual setting is saved and confirmed with the key  or discarded with the key .

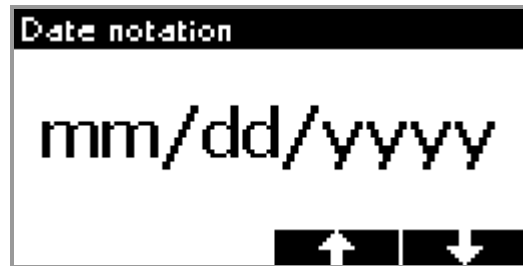
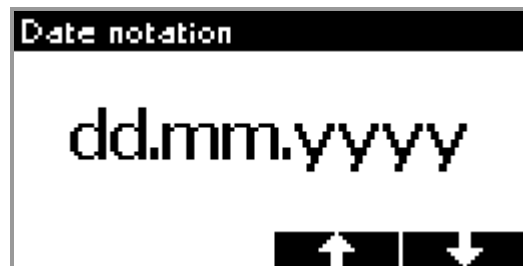



6.9 Time/Date

Directly on the device itself, the time and date can be set.

Just open the menu item "Time/date" in the Settings menu.

Here the function keys  and  choose the location.  and  change the selected value.

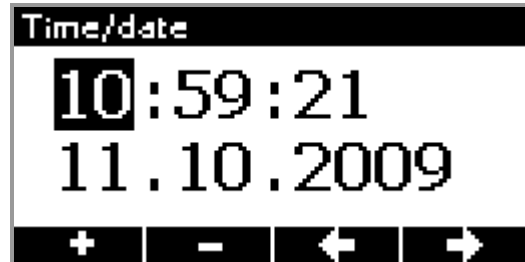
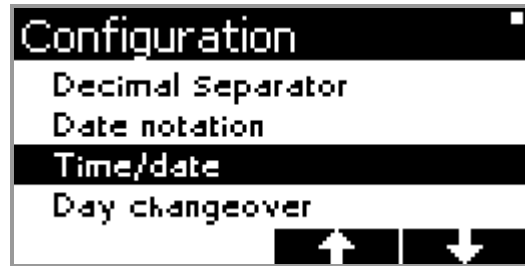

With the key , the new time is accepted.  rejects the input.





6.10 Day changeover



The timing of the day change is important for the settlement. At this time, all volumes are written in the reporting and then set to zero. It should be noted that all tapings till this time count to the previous day - so even to the previous business day.

Factory setting is "04:00" (4 o'clock in the morning). Volumes that have been tapped till this time include the previous business day. At 04:00 then all counters are set to zero and recorded. A new business day starts.

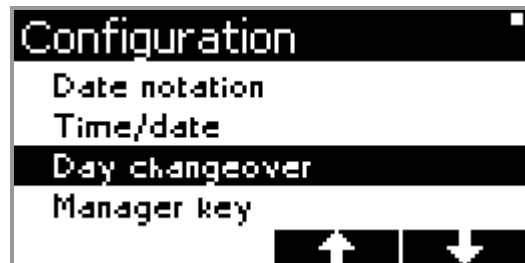

The function keys  and  increase or decrease the day change time by one minute.

With  the input is confirmed, the key  cancels the input and discards the value.



When using the function keys  or  increasing the day change time above 23:59 or decreasing it below 00:00, the text „Off" is shown. This means that no day changeover is done.

ATTENTION: In this case NO periodical reporting is stored, therefore NO reporting can be done! The data (volume) of a line is only stored automatically if the according pulse-memory is getting full (at 40 million pulses).





With , the input is confirmed, the key  cancels the input and discards the value.





6.11 Manager key

The Silexa Draft Beer Counter X3M LZ has an iButton lock on which the application on the device may be performed. The iButton socket wrench can be defined, which keys are allowed to log on. Each key contains a globally unique identification number that is used for authentication.

You can define up to 8 keys. It is always important to define an additional manager key in reserve, since a key cannot be replaced. Alternatively the code application can be used.

The buttons  and  select the first row. With the function button , the key number the selected row can be deleted.  reads the key set and puts the number in the selected row.

The button  takes the new key over in the list. To save them, at least one key had to be defined. With  all the changes can be broken off and discarded the input.

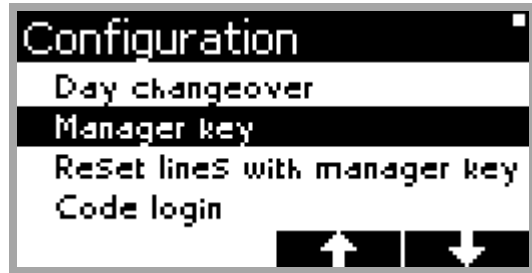

6.12 Reset lines with manager key

Alternatively to the iButton login described above, the manager keys can be used to reset the active lines automatically when a known iButton key is inserted.

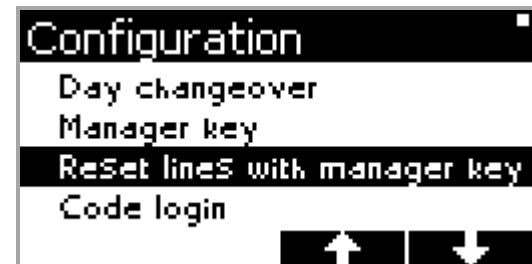

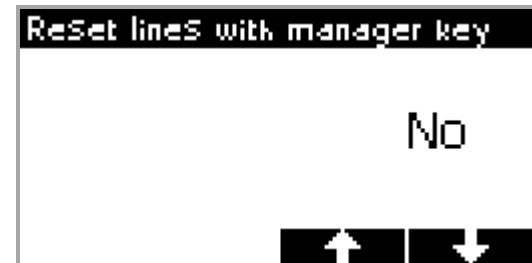

Note: When this option is set to "Yes" and just one line is active, the detail view for this line is shown instead of the standby screen. However by default this function is disabled.



6.13 Code login

In the menu item "Code login" the numerical code for the application via code entry can be defined.

This sequence of numbers is entered with the keys  to , and can be 1 to 10 characters long. The code must be confirmed by a second input - only then it is stored.

If the second input is different from the first, the message "Codes don't match" appears and the command must be carried out again.

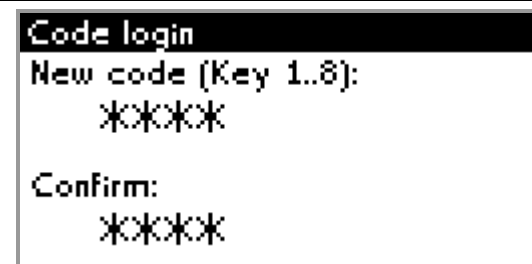



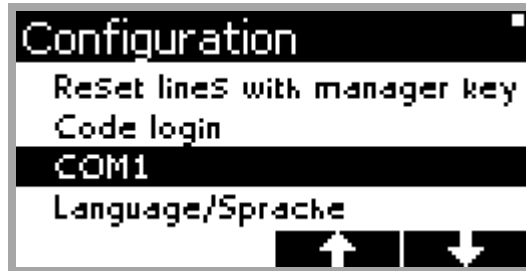

6.14 COM1

The COM1 port of the device can be configured with the menu item "COM1" in the Settings menu.

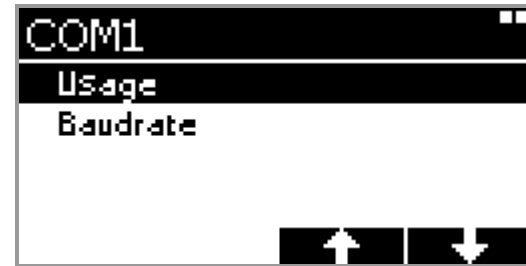





On the one hand, the use is determined, on the other, the baud rate of the interface can be set.



The COM1 port can be used as a printer interface. The buttons  and  select the function, while confirming with .  cancels the selection. If the printer is active, then in the evaluation there is the possibility to print on the external printer. By default, the COM1 port has no fixed use.







In addition to the use the baud rate must be set. Here can be selected with the buttons  and  between 2400, 4800, 9600, 19200, 38400, 57600 and 115200 baud. This change will take place with  or with  the input is discarded.



6.15 Language

In the menu item "Language" the language of the whole device can be changed. You can choose between German and English. After confirmation, the new language immediately will be used.





The new language is selected with the keys  and , confirmed with . The key  discards the input.



6.16 Factory defaults

The function "Factory defaults" puts the entire device with all the settings back to factory setting. The device then reboots and takes over all the new settings.

Caution: This will also erase all data and evaluations.

A security prompt must be confirmed with  before all data are reset. The process is terminated with .

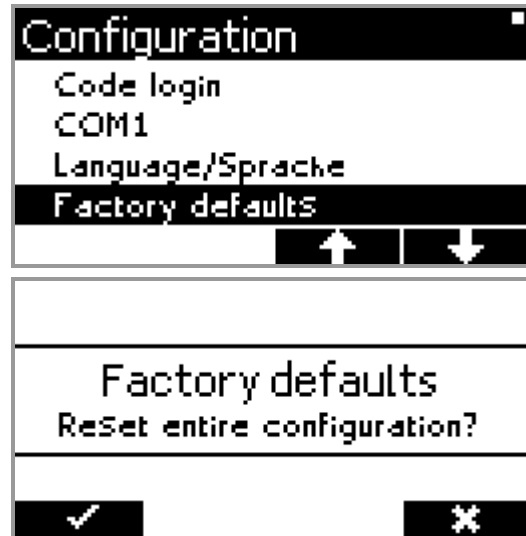

7 Reporting

7.1 General

The Silexa Draft Beer Counter X3M LZ stores sales data for each day and each pipeline permanently. Even during a power outage, the data is not lost.

Depending on the number of lines used, the data can be stored for more than 4 years. A total of 1750 records can be stored, where every day is a separate line for each record.

Therefore, the following retention periods apply:

| Number of pipelines | approximate storage period for sales data |
|---------------------|---|
| 1 | 4 years, 9 months |
| 2 | 2 years, 4 months |
| 3 | 1 year, 7 months |
| 4 | 1 year, 2 months |
| 5 | 11 months |
| 6 | 10 months |
| 7 | 8 months |
| 8 | 7 months |

Is a new day stored in the reservation, the oldest day is discarded. Thus, most recent data is available.

ATTENTION: If day changeover is "Off" (see topic 6.10 "Day changeover"), NO periodical reporting is stored, therefore NO reporting can be done! However, the data (volume) of a pipeline is stored in a non-volatile memory, therefore even in the case of power outage the data is not lost!

The reporting will be elected after the notification for the full menu.



7.2 Select lines

In the menu "Select lines" first choose the pipelines, which should appear in the analysis.

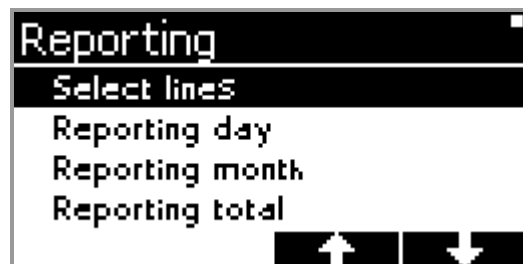

With the keys **1** to **8** you can choose all pipelines, which are relevant for the evaluation. They are displayed in a list on the display.

In the list the commodity number of the pipeline, and the name get displayed.



The selection is confirmed by pressing **OK**.

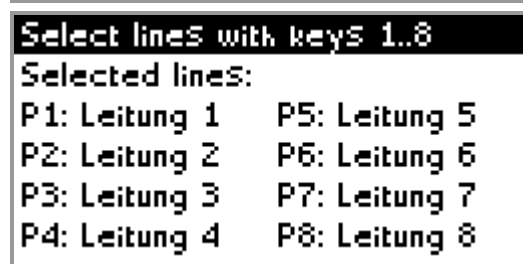

Please note: product pipelines with the same number are consolidated in the analysis.



7.3 Reporting Day

The data of the last business day are displayed in the menu item "Reporting day". You will see a list of all selected pipelines and their commodity numbers. Bottom left appears the sum of all volumes of the day. The date of the reporting appears in the title bar.



The function keys  and  can jump between days. The display gets then updated on the respective day.

| | | | |
|---------------------|--------|---|---|
| Reporting: 10.10.09 | | | |
| P1 | 3,37l | P5 | 0,42l |
| P2 | 1,38l | P6 | 2,78l |
| P3 | 0,83l | P7 | 1,65l |
| P4 | 5,22l | P8 | 2,05l |
| Total | 17,70l |  |  |

7.4 Reporting Month

"Reporting month" shows a table of the current month for the selected pipelines. The analysis period is shown in the title bar.

The function keys  and  choose the previous or next month.

| | | | |
|------------------------------|--------|---|---|
| Reporting: 01.10.09-31.10.09 | | | |
| P1 | 11,14l | P5 | 5,23l |
| P2 | 5,56l | P6 | 9,28l |
| P3 | 8,02l | P7 | 4,85l |
| P4 | 9,30l | P8 | 11,90l |
| Total | 65,28l |  |  |





7.5 Reporting All

The analysis "All" presents all existing data on the device and in a chart.

| | | | |
|----------------|--------|----|--------|
| Reporting: All | | | |
| P1 | 11,14l | P5 | 5,23l |
| P2 | 5,56l | P6 | 9,28l |
| P3 | 8,02l | P7 | 4,85l |
| P4 | 9,30l | P8 | 11,90l |
| Total | 65,28l | | |





7.6 Reporting Timespan

Before displaying a timespan, you have to select the data which should be summed in the menu "Reporting timespan".

 and  selects the field and with the function keys  and  the value of the date increased or decreased.



Confirm the time range with . After confirming the selected time range is presented in a chart.

With  the reporting is completed.

| | |
|---|---|
| Reporting timespan | |
| from | 09.10.2009 |
| to | 11.10.2009 |
|  |  |
|  |  |

| | | | |
|------------------------------|--------|----|-------|
| Reporting: 09.10.09-11.10.09 | | | |
| P1 | 5,69l | P5 | 1,30l |
| P2 | 2,86l | P6 | 4,93l |
| P3 | 4,38l | P7 | 2,81l |
| P4 | 5,79l | P8 | 6,31l |
| Total | 34,07l | | |

7.7 Clear all data

With this function, all reporting data on the device will be erased. The settings and the working data obtain. A security prompt must be confirmed with  before deleting all the data. The process is terminated with .

| | |
|---|---|
| Clear all data | |
| Clear all reporting data? | |
|  |  |

7.8 Reset line(s)

In this menu sales data can be saved and the display of the volume can be cleared for the desired pipelines.
 ATTENTION: If the day changeover is "Off" the desired pipelines are cleared but the actual volumes are NOT stored to the reporting!

With the keys **1** to **8** you can choose those pipelines, which shall be reset. They are displayed in a list on the display.

The following security prompt must be confirmed with **✓** before resetting the chosen lines. The process can be terminated with *****.

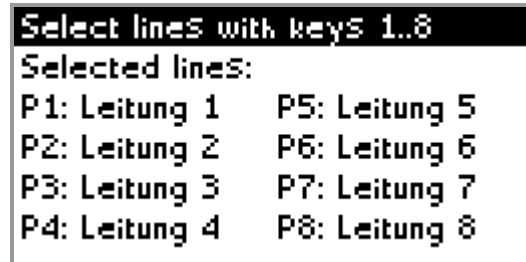
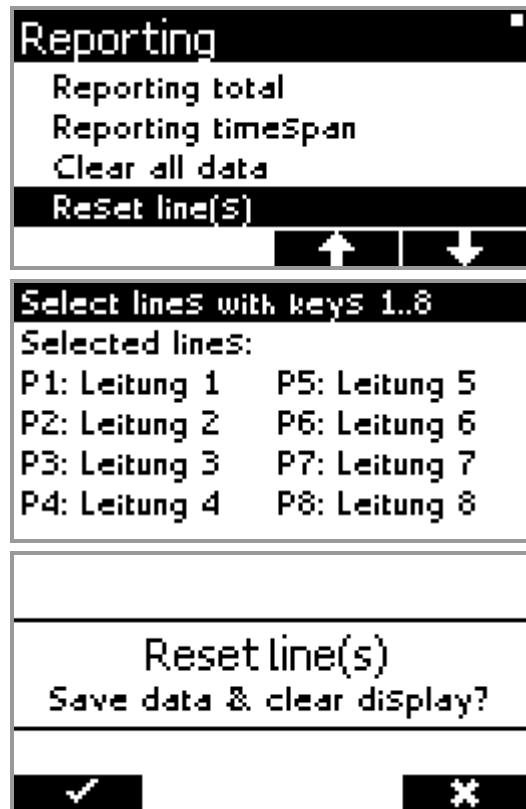

8 Printer

8.1 General

At the Silexa Draft Beer Counter X3M LZ each serial printer can be attached, which supported the ESC / POS protocol. The printer must first be activated in the "Configurations" and then can be used to print reportings.

8.2 Connecting a printer

To connect a printer - cable connections below are required. This cable is represented as a connection diagram or in tabular form.

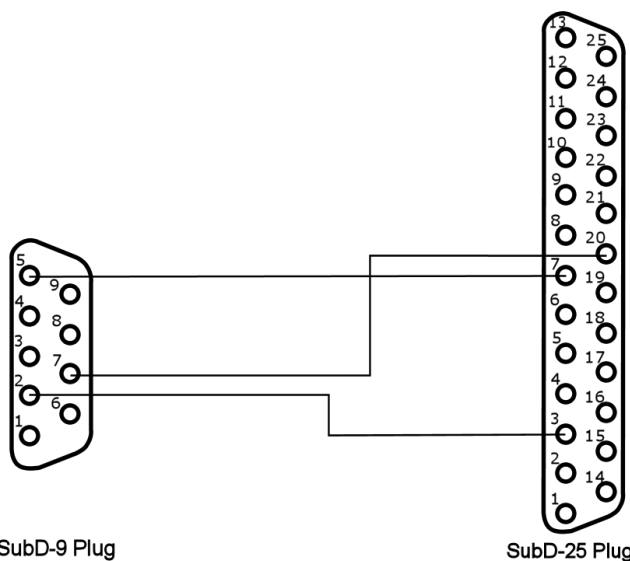

| Draft Beer Counter | Printer |
|--------------------|--------------|
| SubD-9 Plug | SubD-25-Plug |
| Pin 2 | Pin 3 |
| Pin 5 | Pin 7 |
| Pin 7 | Pin 20 |

8.3 Printing reportings

After the printer is configured as explained below „6.12 COM1“, appears in the analysis of views a  printer icon button. By clicking the button the current view can now be printed.

It briefly shows the message "Printing...".

| Reporting: All | | | |
|--|--------|----|--------|
| P1 | 11,14l | P5 | 5,23l |
| P2 | 5,56l | P6 | 0,78l |
| Printing... | | | |
| P4 | 9,30l | P8 | 11,90l |
|  | 65,28l | | |

Should the printer not or incorrectly connected, it will be also reported. The error report is available in German and in English. They are printed according to the selected language.

| Reporting: All | | | |
|--|--------|----|--------|
| P1 | 11,14l | P5 | 5,23l |
| P2 | 5,56l | P6 | 0,78l |
| Printer not ready | | | |
| P4 | 9,30l | P8 | 11,90l |
|  | 65,28l | | |

| Auswertung | |
|--------------------------|---------|
| Auswertung Tag: 10.10.09 | |
| Datum: 11.10.09 10:08:35 | |
| PLU Bezeichnung | Volumen |
| 001 Leitung 1 | 3,37 l |
| 002 Leitung 2 | 1,38 l |
| 003 Pils 3 | 0,83 l |
| 004 Leitung 4 | 5,22 l |
| 005 Leitung 5 | 0,42 l |
| 006 Leitung 6 | 2,78 l |
| 007 Leitung 7 | 1,65 l |
| 008 Leitung 8 | 2,05 l |
| Summe | 17,70 l |



| Reporting | |
|-------------------------|---------|
| Reporting day: 10.10.09 | |
| Date: 11.10.09 11:23:27 | |
| PLU Name | Volume |
| 001 Leitung 1 | 3,37 l |
| 002 Leitung 2 | 1,38 l |
| 003 Pils 3 | 0,83 l |
| 004 Leitung 4 | 5,22 l |
| 005 Leitung 5 | 0,42 l |
| 006 Leitung 6 | 2,78 l |
| 007 Leitung 7 | 1,65 l |
| 008 Leitung 8 | 2,05 l |
| Total | 17,70 l |

9 Cleaning

The cleaning function ensures genuine reporting data during a cleaning.

If the cleaning mode is active, no sales data are generated and no volumes counted. The beginning and the end of the cleaning process are recorded in the occurrences.

The cleaning process is started in full with the main menu item "Cleaning".

With the key  or  the process is again finished.

| Main menu | |
|---|--|
| Reporting | |
| Cleaning | |
| Configuration | |
| Events | |
|   | |

Cleaning
All lines can be cleaned now. At the moment the turnover is not being counted.

10 Events

10.1 General

During operation of the Silexa Draft Beer Counter X3M LZ runs an events system in the background, which takes notes of all the important dates and makes them available for inspection. Recorded events are:

- Switching to grid operation
- Switching to battery
- Blackout
- Disconnecting a flow meter
- Connecting a flow meter
- Resetting a pipeline
- Restart the device
- Delete the reporting data
- Reset to Factory Defaults
- Start cleaning
- End cleaning

Up to 500 events are stored with time stamp in memory of the device. The memory device do not lose any data during a power outage. Every new event is displayed with a flag icon as unread. They can be marked as read and confirmed in the events list. The event lists can be displayed filtered by category.

10.2 New events





New events are also shown on the standby screen in the title bar on the right above, as a flag icon .

As soon as at least an unread event is available, this icon will appear. When all event have been confirmed, it disappears again.

In the category "New events" only those events which are new and not confirmed.

Each event is represented within two lines. In the first line there is the text of this entry and a flag icon to the right if the event has not been confirmed. Below is a timestamp with time and date of occurrence of the event.

Bottom left appears the total number of entries in this list and the number of the selected events.

In the event list can be navigated with the function keys  and  in the events. With  the selected event is confirmed to be read. The key  is leaving the View.

| | | | |
|--|-------|---|--------|
| 11.10.09 09:22:14  | | | |
| 1 | 2,65l | 5 | 5,28l |
| 2 | 2,06l | 6 | 21,22l |
| 3 | 0,72l | 7 | 4,48l |
| 4 | 3,81l | 8 | 2,68l |



Events 

New events

All events

Power Supply

Flowmeter

Mains Supply 



11.10.09 11:12:58

Battery Supply 

11.10.09 11:12:57

Start

11.10.09 10:52:13

1 | 10  

Flowmeter 8 disconnected 

11.10.09 10:04:32

Flowmeter 8 connected 

11.10.09 10:04:28



Battery Supply 

11.10.09 10:03:10

1 | 3  

10.3 All events

Within the menu item "All events" all existing occurrences of every category, no matter if they confirmed or not are displayed.

Also in this view  is confirming the selected events as read. The key  is leaving the View.

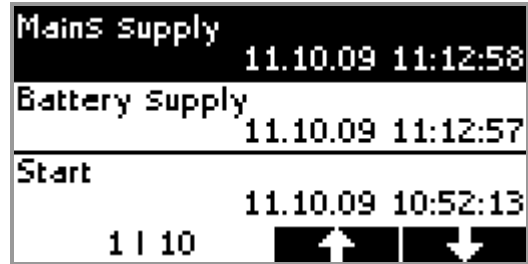

10.4 Power supply

The category "Power supply" includes the following events:

- Switch to grid operation
- Switch to battery
- Blackout
- Restart the device

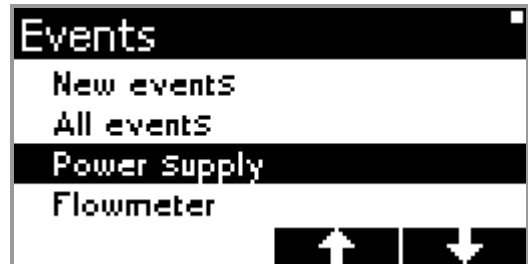

10.5 Flow meter

In the menu "Flowmeter" occurrences get displayed which relate to the flow meter. Those including:

- Finalizing a flow meter
- Connecting a flow meter
- Resetting a pipeline

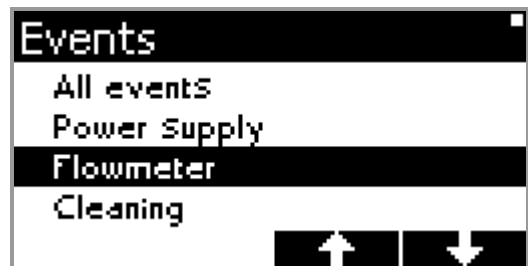

10.6 Cleaning

The category "Cleaning" is restricted to:

- Start of Cleaning
- End of Cleaning

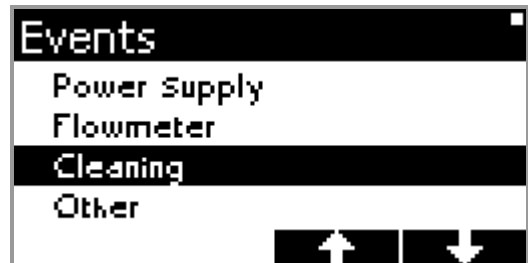

10.7 Other

In the group "Other" appearing the events for:

- Restart the device
- Delete the evaluation data
- Reset to Factory Defaults

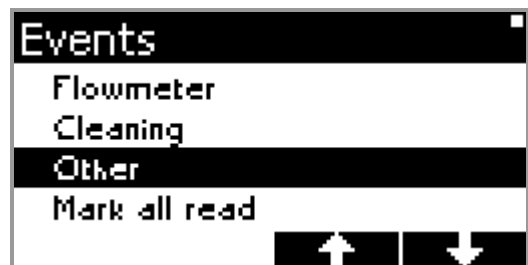

10.8 Mark all as read

To confirm not all entries individually, you are be able to mark all events as read at once with this function.

An additional inquiry must be confirmed with  before the operation is carried out.



10.9 Clear all data

„Clear all data“ will clear the occurrence memory. The configuration and the evaluation data will remain unchanged.

A security prompt must be confirmed with  before the delete operation gets performed.

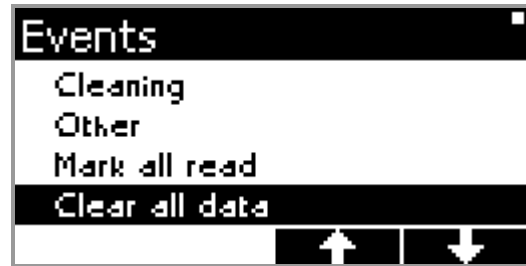

11 Battery operation



Optionally the Silexa Draft Beer Counter X3M LZ can be equipped with a backup battery. A standard 9V battery is used.



Depending on the number of used flow meter, a battery lasts for about 2 to 3 hours. Then the device turns off. Even with a failure from the battery, no data is lost. The real time clock is additionally supported by a button battery, so it continues when there is a power failure.

Once the battery is connected, a battery icon  gets displayed in the title bar of the standby screen. It indicates the presence of the battery, but not the remaining capacity.

In the event of a power failure the battery will be uninterrupted active. After a determine short time the remaining capacity will be displayed in percent. To the right it's shown graphically.

Please note: To save power dims the backlight of the display to about 20% of brightness.

| 11.10.09 09:22:14   | | | |
|---|-------|---|--------|
| 1 | 2,65l | 5 | 5,28l |
| 2 | 2,06l | 6 | 21,22l |
| 3 | 0,72l | 7 | 4,48l |
| 4 | 3,81l | 8 | 2,68l |

| 11.10.09 10:03:20 53%   | | | |
|---|-------|---|--------|
| 1 | 2,66l | 5 | 5,28l |
| 2 | 2,06l | 6 | 21,22l |
| 3 | 0,48l | 7 | 4,48l |
| 4 | 3,81l | 8 | 2,68l |